

SAHLBERG

100 years of intelligent solutions

The new solution for air handling units

Resilient Mountings with KSD[®] Compact



The new solution for air handling units

With its KSD® Compact product line, SAHLBERG launches a new product family of double elastic support units for insulation against structure-borne noise and vibrations. KSD® Compact is specially optimized for use under air handling units. The principle of the double elastic support has been successfully used for many years with KSD®-Elements. KSD® Compact comes with smaller dimensions, lower component weights, a reduced structure height, lower minimum loads and last but not least, at a lower cost per unit.



Tender specification

KSD® Compact units are suitable for punctual installation of air handling units and provide insulation against structure-borne noise and vibrations.

The units are composed of two layers of a mixed-cell polyurethane elastomer that are separated by a heavy intermediate mass. On the upper side, the units have a hot-dip galvanized load spreading plate. The steel plate is dimensioned so that the line and point loads are spread evenly across the elastomer surface.

The delivery includes a friction mat that is to be placed between the bottom or frame of the unit and the load spreading plate.

For different loads there are 5 different types of KSD® Compact, all of which have the same outer dimensions. They can be combined with each other depending on the required load.

The information given in the section "Required information about air handling unit" is necessary for the dimensioning of an elastic support with KSD® Compact.

Summary

- KSD® Compact
- Different type for each load category
- Dimensions for all types:
 - Length: 140 mm
 - Width: 140 mm
 - Height (unloaded): 96 mm
- Weight: 8 kg
- Consists of: load spreading plate, upper elastic layer, intermediate mass and lower elastic layer

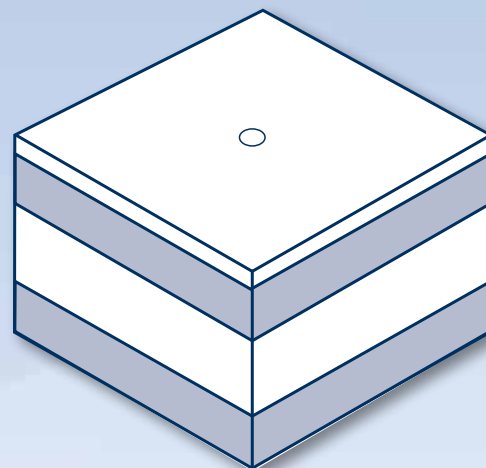

Basic mode of operation

Double-elastic properties of KSD® Compact provide a generally lower discharge of structure-borne noise and vibration into the surrounding structural design compared to single-elastic support.

The diagram below illustrates the noise level difference for frequency in a single versus double-elastic mounting on KSD® Compact.

The measured difference in structure-borne noise level of a single versus double-elastic support

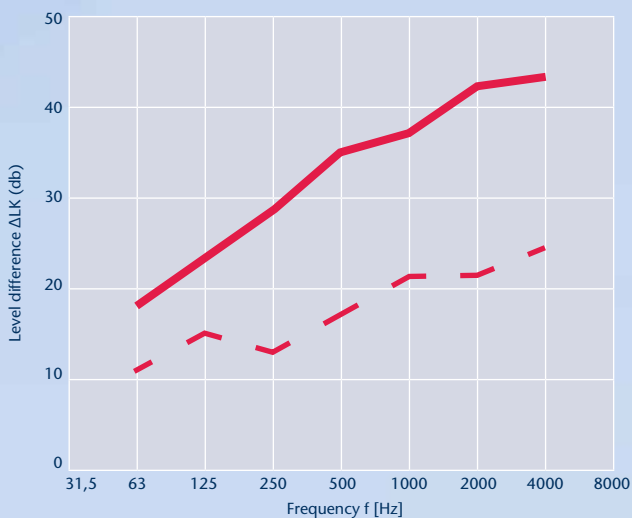

Technical explanation

Ventilation and air conditioning units are frequently mounted immediately adjacent to rooms with the need for extensive insulation from structure-borne noise (housing, offices, hotel rooms).

In order to avoid noise from the transmission of mechanical vibrations, a single elastic mounting (e.g. on elastomer strips) is often insufficient. With a double-elastic mounting, there is usually better insulation from structure-borne noise and vibrations, but more space is needed for the support. KSD® Compact provides better insulation from structure-borne noise and vibrations with a construction height of just 96 mm in rooms with limited space.

Why risk future complaints from tenants or building owners when making the right choice during planning is the simple solution to solve noise problems.



Installation

KSD® Compact can easily be mounted under the frame of the air handling unit that is to be installed. For vertical loads, the elements usually do not need to be screwed or otherwise fixed. Each element is delivered with a friction mat that is set between the bottom or frame of the unit and the load spreading plate to avoid slipping. KSD® Compact Elements are available in the same dimensions (140 x 140 x 96 mm) for different nominal loads (up to 8 kN). Thus there is always the same statical deflection over the entire length of the unit.

Required information about the air handling unit

The unit's dimensions, weight and frame dimensions are required for the design of the KSD® Compact Element. Ventilator speed and number of blades are likewise needed. To identify local structural dynamics, indicate ceiling thickness, floor structure where the technical room is located within the building, as well as how adjacent rooms are used.

KSD® Compact statical deflections

KSD® Compact Type 5

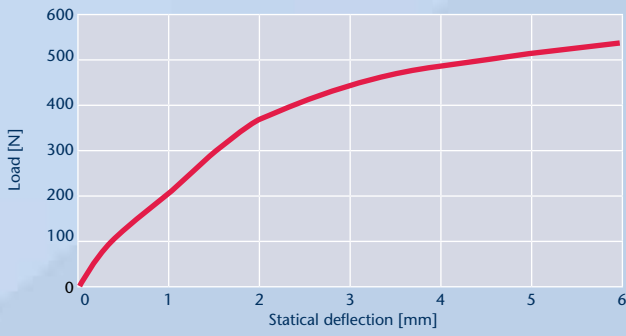

KSD® Compact Type 10

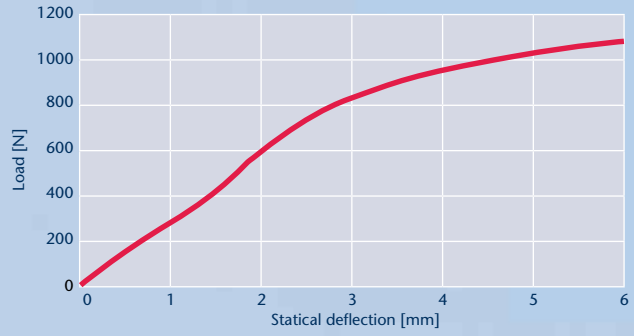

KSD® Compact Type 20

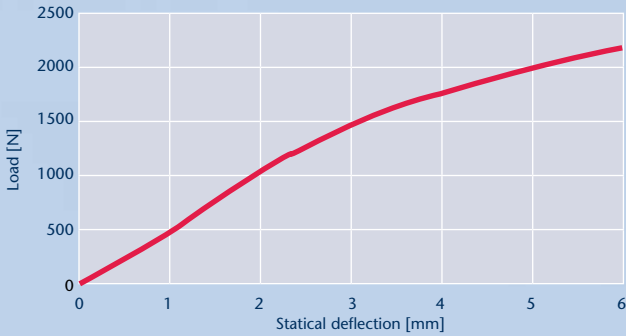

KSD® Compact Type 40

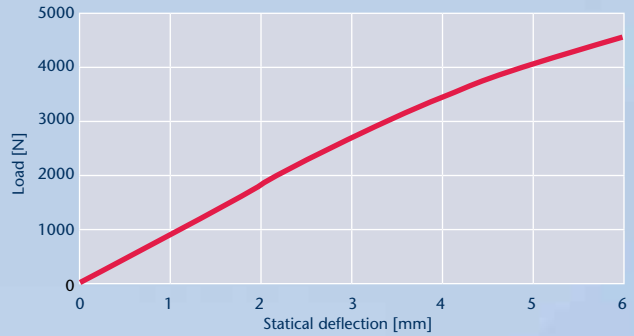

KSD® Compact Type 80

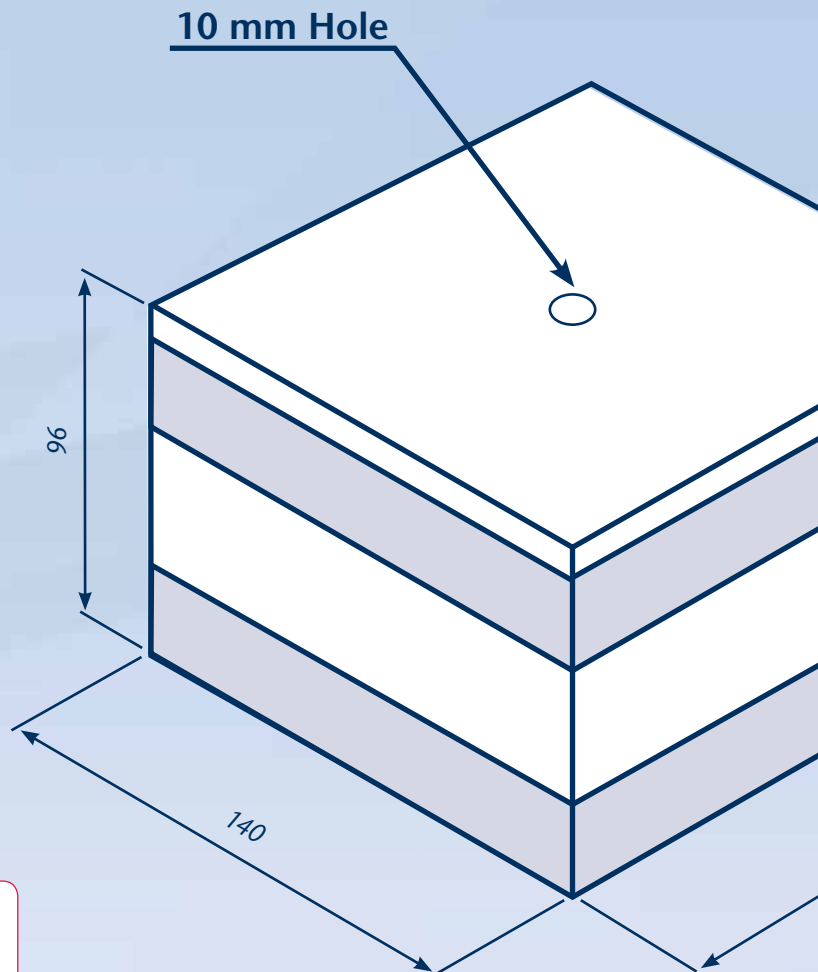
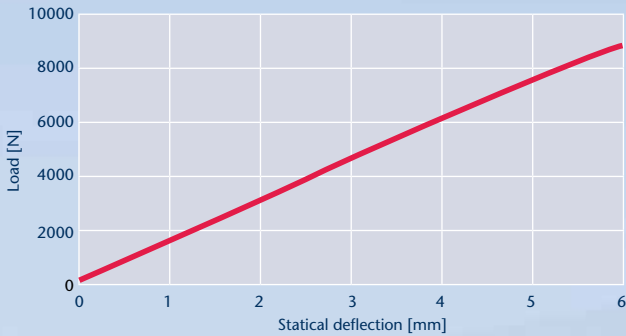

KSD® Compact comes with a friction mat to be set between the bottom or frame of the unit and the load spreading plate.

KSD® Compact lower natural frequencies

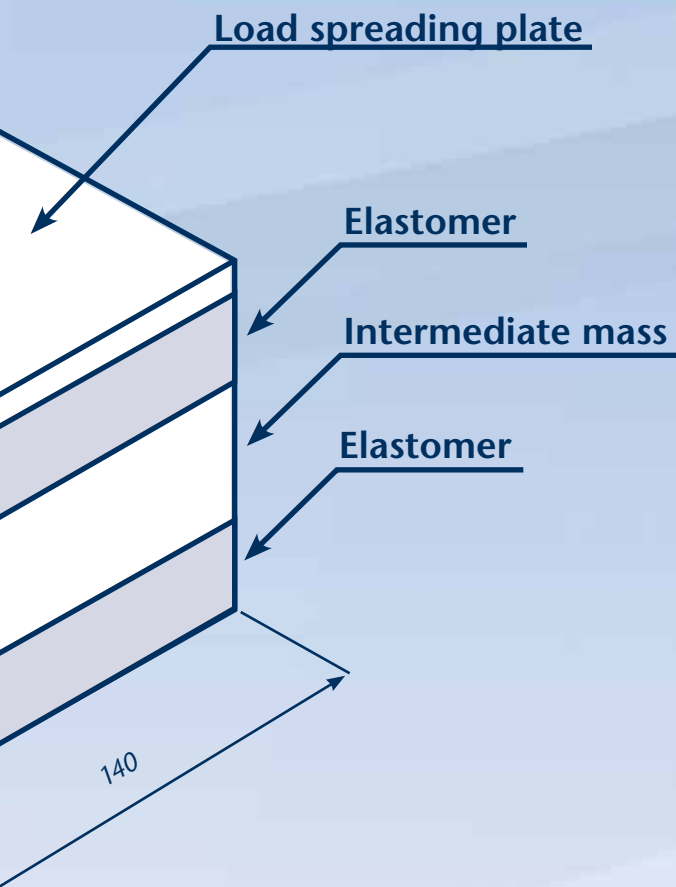
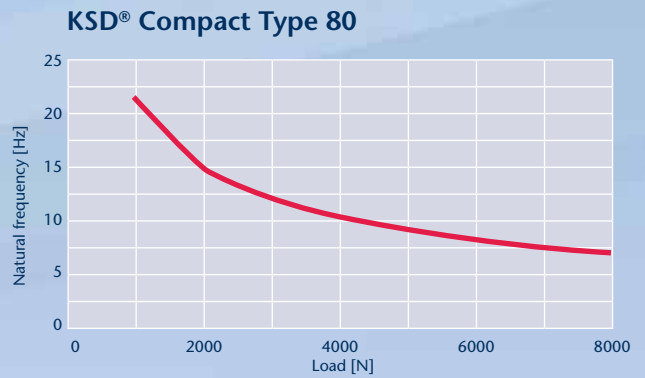
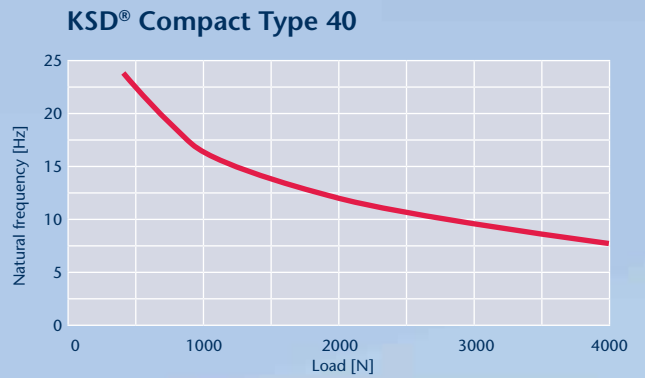
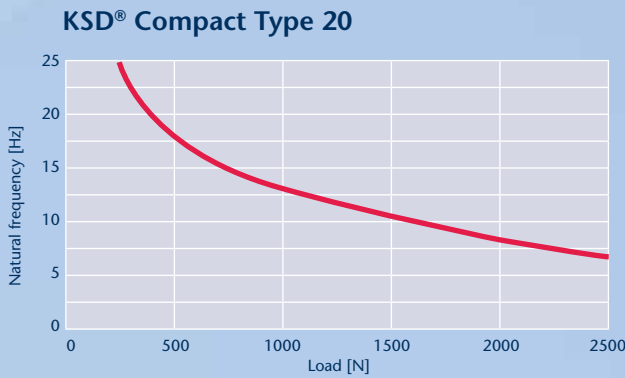
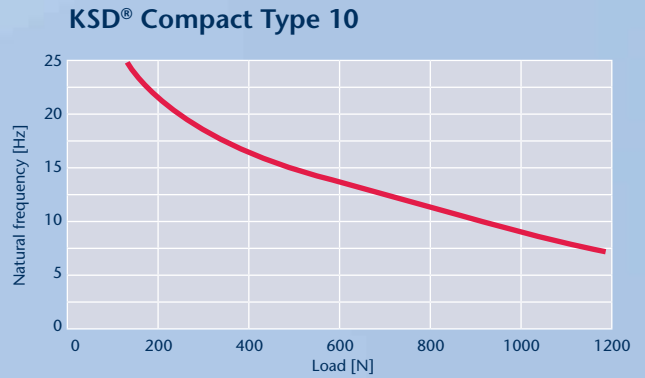
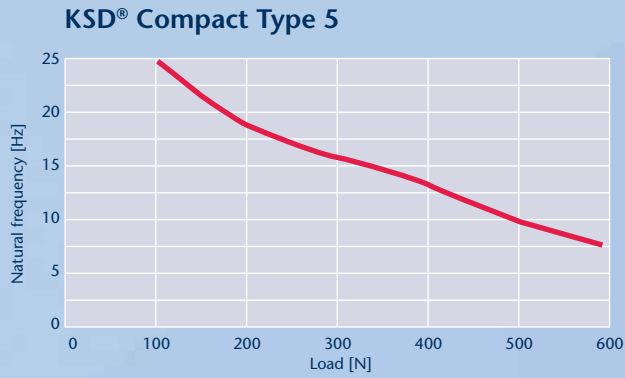

Designation	Color	Statical load
KSD® Compact Type 5	blue	500 N
KSD® Compact Type 10	green	1000 N
KSD® Compact Type 20	brown	2100 N
KSD® Compact Type 40	red	4000 N
KSD® Compact Type 80	grey	8000 N



Contact

Advice on application

Mr. Christopher Paul

Tel. +49 (0) 89/99 135 -135

Fax +49 (0) 89/99 135 -164

christopher.paul@sahlberg.de

Commercial advice

Ms. Sandy Heck

Tel. +49 (0) 89/99 135 -185

Fax +49 (0) 89/99 135 -164

sandy.heck@sahlberg.de

SAHLBERG GmbH & Co. KG
Friedrich-Schuele-Strasse 20
DE-85622 Feldkirchen / Munich
Tel. +49 (0) 89/99 135 - 0
Fax +49 (0) 89/99 135 -120

info@sahlberg.de

www.sahlberg.de

Copyright 2012

SAHLBERG GmbH & Co. KG
DE-85622 Feldkirchen / Munich

SAHLBERG is an EC-wide registered trademark of SAHLBERG GmbH & Co. KG

This brochure has been prepared with great attention to detail. However, there may still be errors. For this reason we assume no form of liability and provide no guarantees for its accuracy. This information is subject to change and is provided without liability. KSD® is a registered trademark of BBM Akustik Technologie GmbH. KSD® Compact are exclusively sold by SAHLBERG for BBM Akustik Technologie.